

Experiments with a Software Defined Radio Telescope

1. Introduction

This paper describes recent experiments carried out to determine the performance of an amateur radio telescope employing a Software Defined Radio (SDR) receiver in place of a conventional communications receiver.

One motivation for conducting this experiment is the emergence of low cost, capable SDR components that when connected to a suitable antenna and Low Noise Amplifier (LNA) might result in a low budget radio telescope that is well within the range of most people who wish to become amateur radio astronomers.

It is conceivable that low cost radio telescope kits could become available at a fraction of the cost of current equipment. Such a system, with useful performance, could encourage a number of individuals and astronomical societies and clubs to take up this fascinating activity.

2. Software Defined Radio

A number of definitions can be found to describe Software Defined Radio or SDR. The Wireless Innovation Forum¹, working in collaboration with the Institute of Electrical and Electronic Engineers (IEEE) P1900.1 group, has worked to establish a definition of SDR that provides consistency and a clear overview of the technology and its associated benefits. Simply put, Software Defined Radio is defined as:

"Radio in which some or all of the physical layer functions are software defined".

Software-defined radio is an implementation of a radio communication system where components that have normally been implemented in hardware (e.g. low noise amplifiers, mixers, filters, IF amplifiers, modulators/demodulators and detectors), are instead implemented by means of software on a personal computer or other computing devices. While SDR is not new, the rapidly developing capability of digital electronics makes practical many processes which used to be only conceptual².

Large amounts of signal processing are carried out in a general-purpose processor, rather than being done in special-to-type hardware. This type of design produces a radio which can receive signals over a very wide band of frequencies (eg 50 to 2500MHz) without changing any hardware. SDR also permits different radio protocols to be accessed by using appropriate software modules.

High performance software defined radios have been vigorously developed in the last decade, providing significant utility for the military and cell phone services, both of which must be flexible and capable of reconfiguration to respond to changing requirements.

3. Fun Cube Dongle

The Fun Cube Dongle or 'FCD' is an SDR product that has recently become available in small numbers and which has been bought by amateur radio enthusiasts around the world who wish to become involved with this new technology and explore its many applications.

The idea behind the development of this device was to make available a low cost unit capable of receiving signals from the FUNcube amateur satellite. This is a 'CubeSat' - which is a standardized format for micro-satellites having a size of 10cm x 10cm x 10cm.

The FUNcube Project is a new amateur satellite project that features a 435 to 145 MHz Linear Transponder for SSB/CW operation. The project has received major initial funding from the Radio Communications Foundation (RCF)³ and is being developed in collaboration with ISIS-Innovative Solutions in Space BV.

FUNcube-1 is a complete educational single CubeSat project with the goal of enthusing and educating young people about radio, space, physics and electronics.

FUNcube Dongle is the "ground segment", or a radio receiver, designed to allow anyone to try their hand at reception of satellites like FUNcube anywhere on Earth as part of a global educational collaboration project collecting information from space.

The useful frequency coverage is from 51.5MHz or so – to the upper frequency limit of beyond 2,000MHz. The FCD has no restriction on modulation schemes: it is limited only by the application program running on the host computer. As long as the signal fits within about an 80kHz bandwidth, the unit is capable of receiving the radio signal. The device can be configured for AM reception, as well as for wide band FM, narrow band FM, SSB and CW.

The sensitivity of the FCD is 0.15uV for 12dB SINAD NBFM at 145MHz and 435MHz

For a full description of the FUNcube Satellite see their web site ⁴.

For more information on the FUNcube Dongle – see ⁵.

Figure 1 shows a picture of the FUNcube Dongle.



Figure 1 FUNcube Dongle Software Defined Radio

Experiments with a Software Defined Radio Telescope

4. Preliminary testing of FCD

In order to use the FCD with confidence for radio astronomy, it is necessary to make some preliminary measurements to understand its performance in some detail. In particular, it is important to ascertain the stability of the device over the extended periods of time required to make astronomical observations.

There are two key measurements to make:

- Frequency stability
- Gain & noise stability

The frequency stability of the FCD tested is shown in Figure 2. The frequency drift following device power up can clearly be seen. However stability is achieved quite quickly – in about 30 minutes.

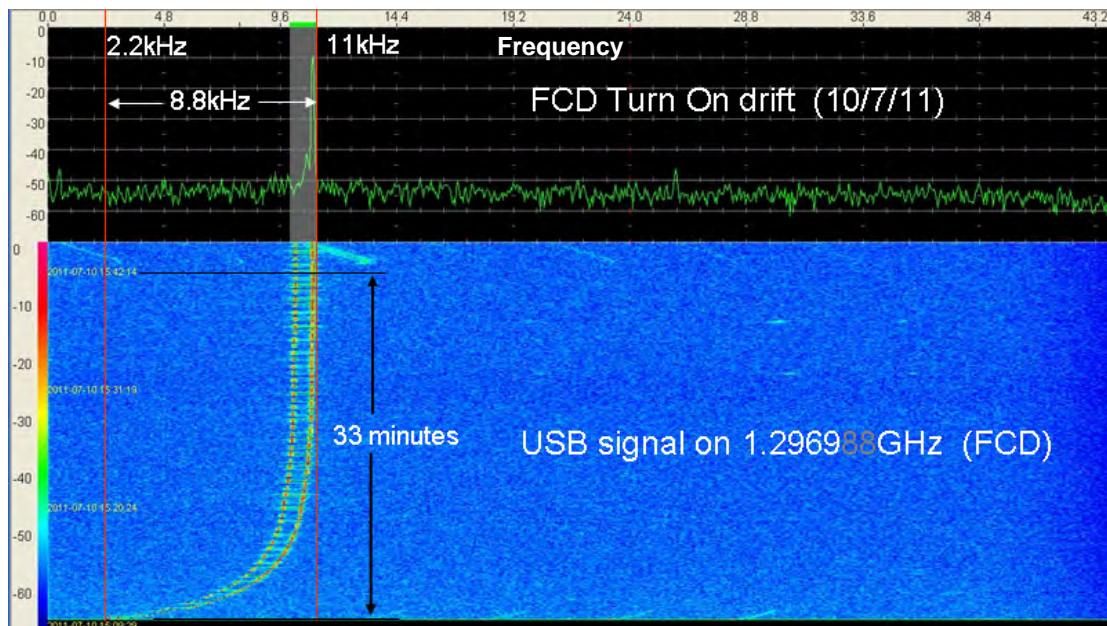

Figure 2 Turn ON frequency drift of FCD

A readily available stable USB transmission at an FCD indicated frequency of 1296.9 MHz was used to show the <10kHz frequency drift when the device is first turned on. After approximately 30 minutes the drift has reduced to a negligible amount – presumably the electronic components in the FCD have achieved thermal equilibrium with their surroundings.

The gain / noise stability of the device was assessed after it had been powered for more than 30 minutes. The result is shown in Figure 3.

Experiments with a Software Defined Radio Telescope

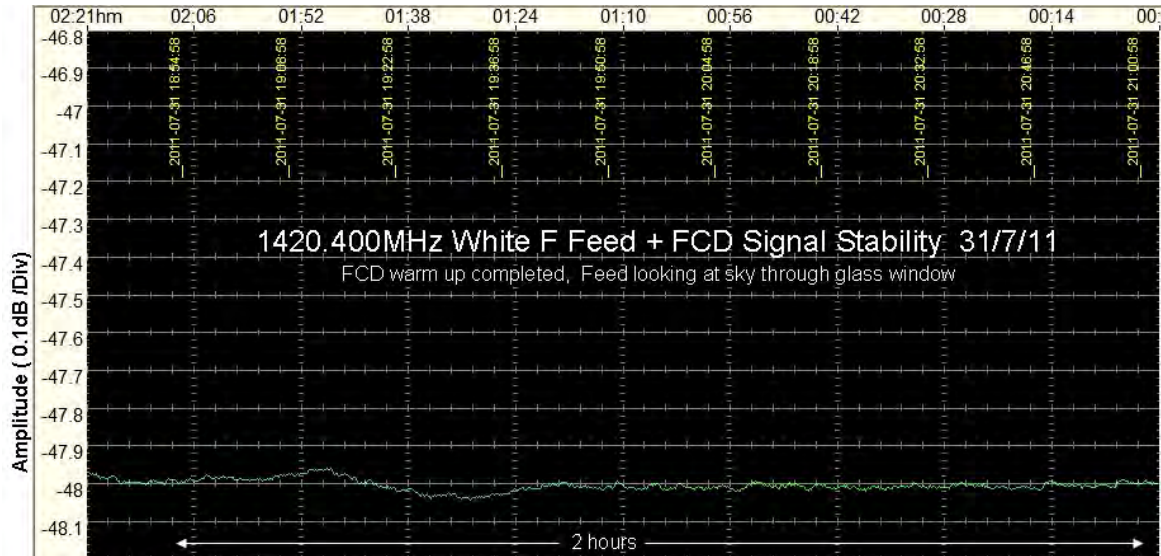

Figure 3 Gain / noise stability of FCD (+ noise source)

The FCD gain / noise stability is better than that shown in Figure 3. The graph shows the total signal level from the radio telescope feed with its preamplifiers (but not mounted in the 3m dish) when connected to the FCD. The total signal is constant to about $\pm 0.05\text{dB}$ which is adequate for radio observations of signals from the Milky Way for example.

Experiments with a Software Defined Radio Telescope

5. Experimental Configuration

5.1 Hardware configuration

The configuration of equipment for the experiment to measure the 1420MHz radio emission from the galactic plane is shown in Figure 4. The system is very simple; it has only 3 major components.

- Dish and feed
- FCD SDR
- Laptop and software

Because of this, the system has the potential to become the universal amateur radio astronomy low cost equipment kit.

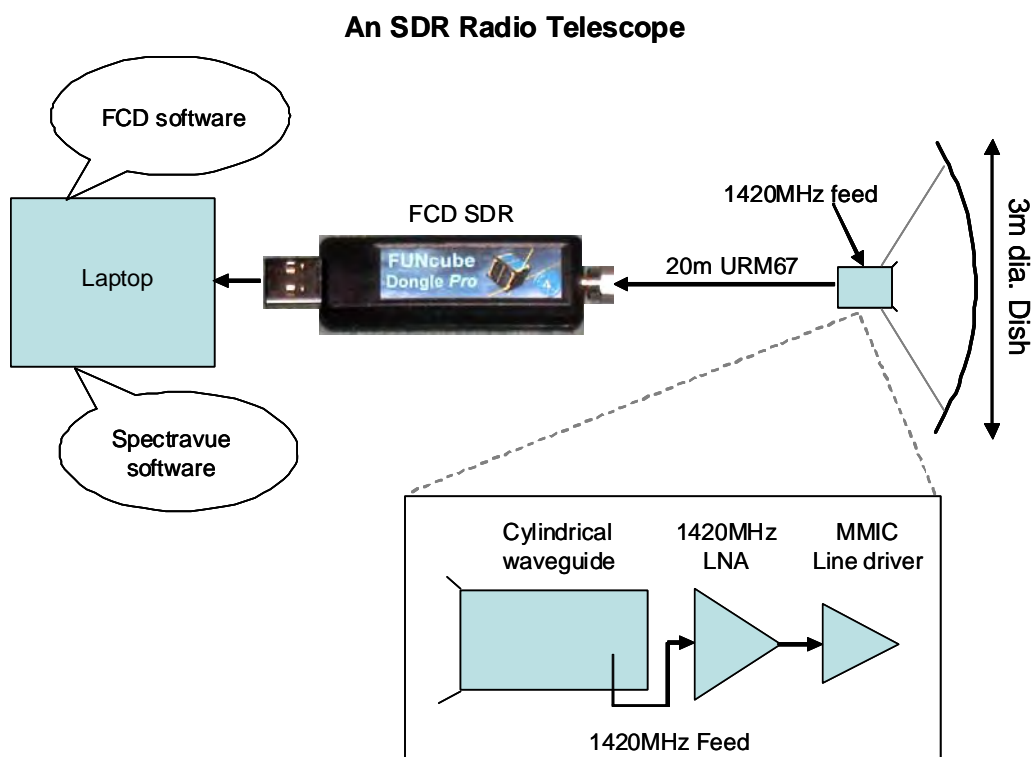

Figure 4 Hardware configuration

5.2 Software configuration

There are two pieces of software that are required to operate the SDR radio telescope. The first drives the FCD and is shown in Figure 5 and can be downloaded from the FCD user group resource ⁶.

The second is a suitable SDR spectrum creator / viewer such as WR+, Spectrum Lab or SpectraVue. In this experiment, SpectraVue was used and can be downloaded from ⁷. The main operating window is shown in Figure 6.

Experiments with a Software Defined Radio Telescope

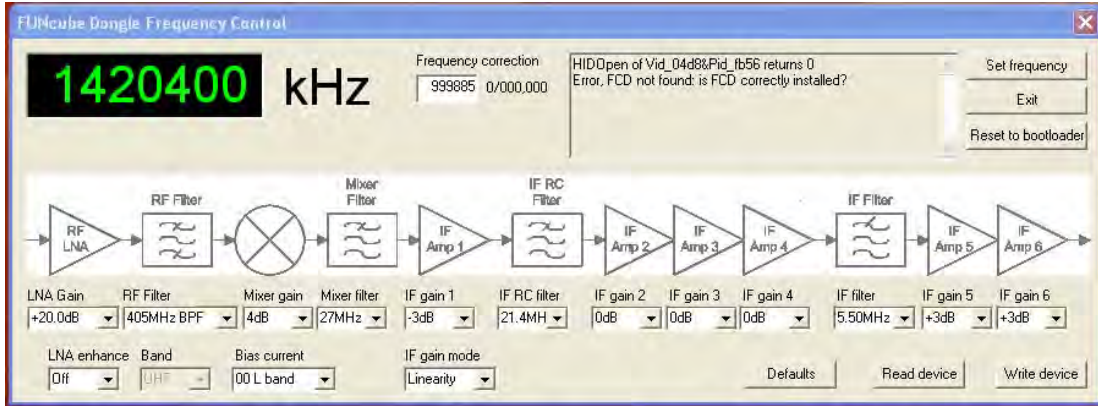

Figure 5 FUNcube Dongle interface software

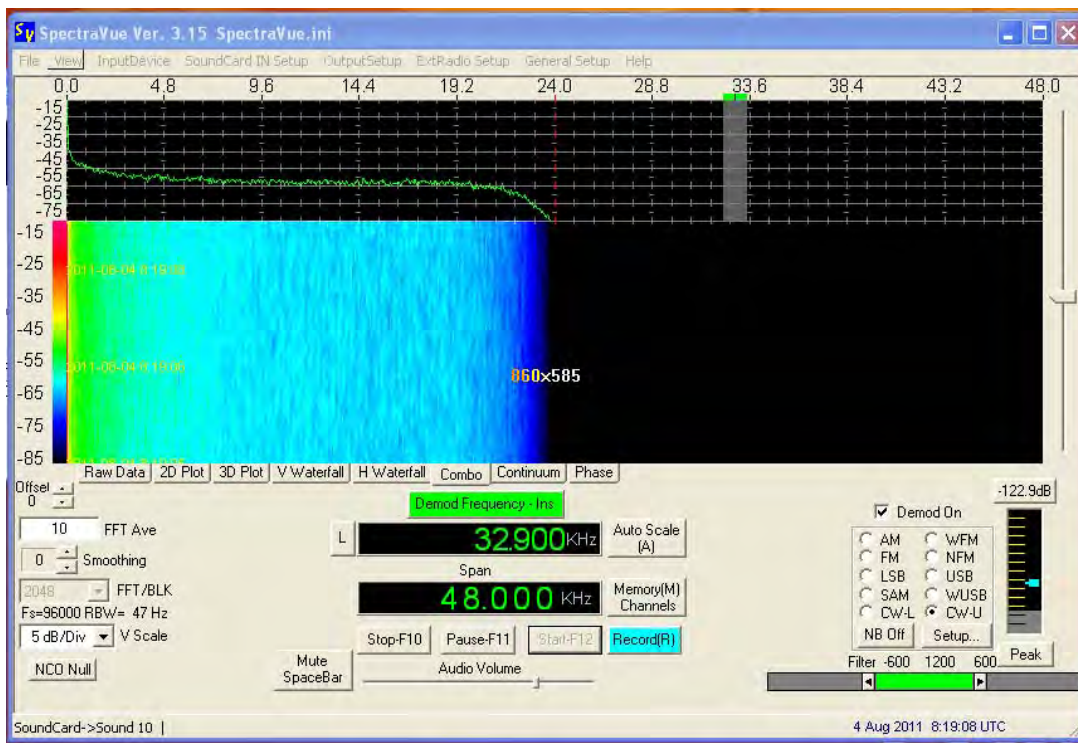

Figure 6 SpectraVue Spectrum analyser / SDR demodulator

The details of operating these software packages will not be described here as this information is available from the program 'help' files.

Experiments with a Software Defined Radio Telescope

6. **An experiment to indicate the sensitivity of the SDR telescope**
The antenna used was a deep paraboloidal dish with focal ratio $F=0.28$ and a cylindrical waveguide feed⁸ as shown in Figure 7.



Figure 7 3m diameter dish with waveguide feed

The beam pattern of the dish /feed combination is shown in Figure 8. The -3dB beamwidth is 8° .

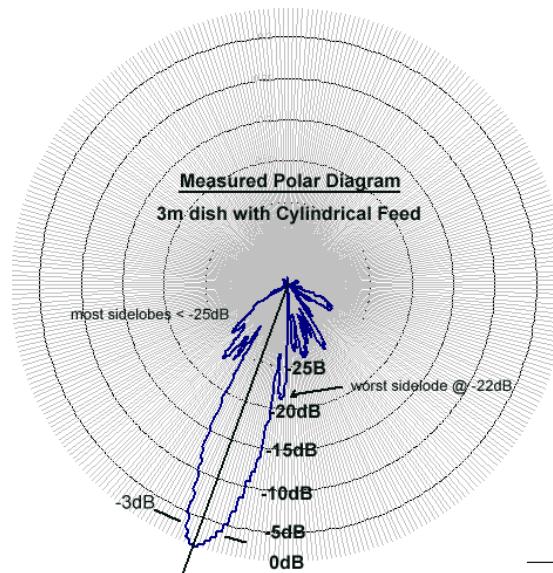

Figure 8 Polar diagram of antenna used in SDR experiment

In many previous radio astronomy measurements using conventional receivers such as the Icom IC-R7000⁹, it has been useful to assess the performance of the system by comparing the signal strength from a

Experiments with a Software Defined Radio Telescope

cold sky – with the dish pointing at high elevation, to the hot ground – with the dish pointing downward. The result is shown in Figure 9.

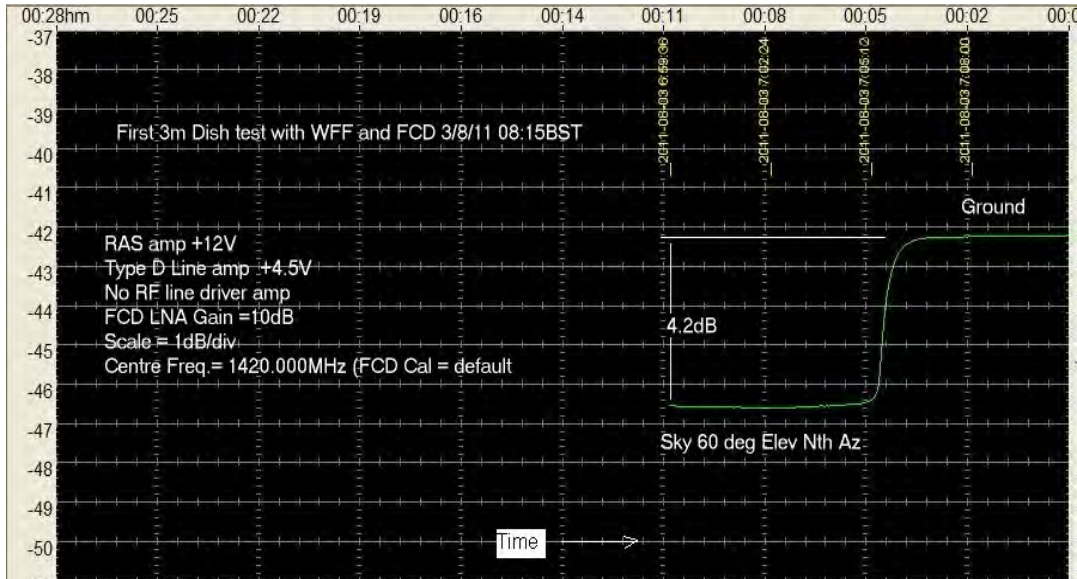

Figure 9 Signal level comparison: cold sky to warm ground

The green trace shows the change in signal strength as the elevation of the dish is lowered from $+60^{\circ}$ to 0° over the period of a couple of minutes. In this simple test we see at least 4dB difference between the two conditions. An indication of this level of sensitivity suggests that a successful detection of the galactic plane emission can be made as the noise stability for the SDR system has been shown in Figure 3 to vary by less than 0.05dB.

Experiments with a Software Defined Radio Telescope

7. Setting up observing parameters

In order to conduct the measurement of the emission from the galactic plane it is necessary to plan the timing and pointing parameters for the experiment. This is done using Radio Eyes software¹⁰ which presents a picture of the 'Radio Sky' at 1420MHz along with all requested geometric and astronomical axes as shown in Figure 10.

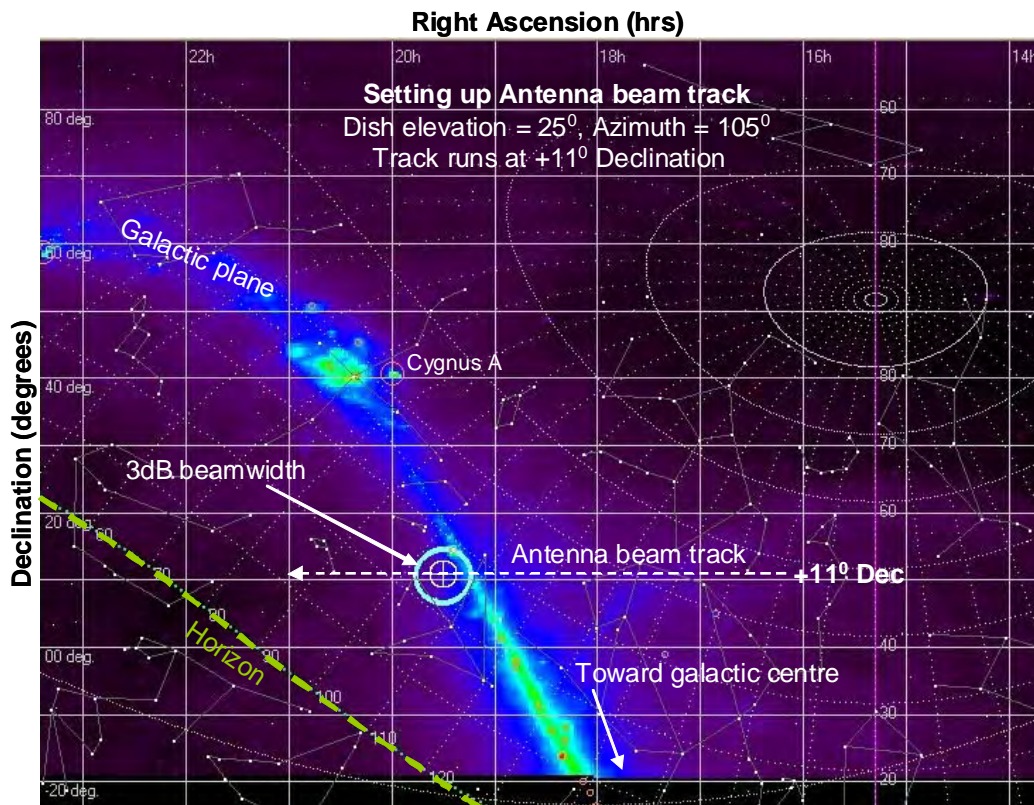

Figure 10 Setting up observing parameters with Radio Eyes

The lowest practical dish elevation at the observing site is 25° . This is to avoid leakage of thermal signal from the warm ground entering the beam and swamping the wanted galactic noise emission. Signal strength measurements were made over approximately 2 hours as the galactic plane transited the antenna beam.

Experiments with a Software Defined Radio Telescope

8. Measurement results

The SpectraVue software was used to record the received signal strength (green trace) every 10 seconds over a period of approximately 2 hours from 17:24UT to ~19:20 UT. The result is shown in Figure 11.

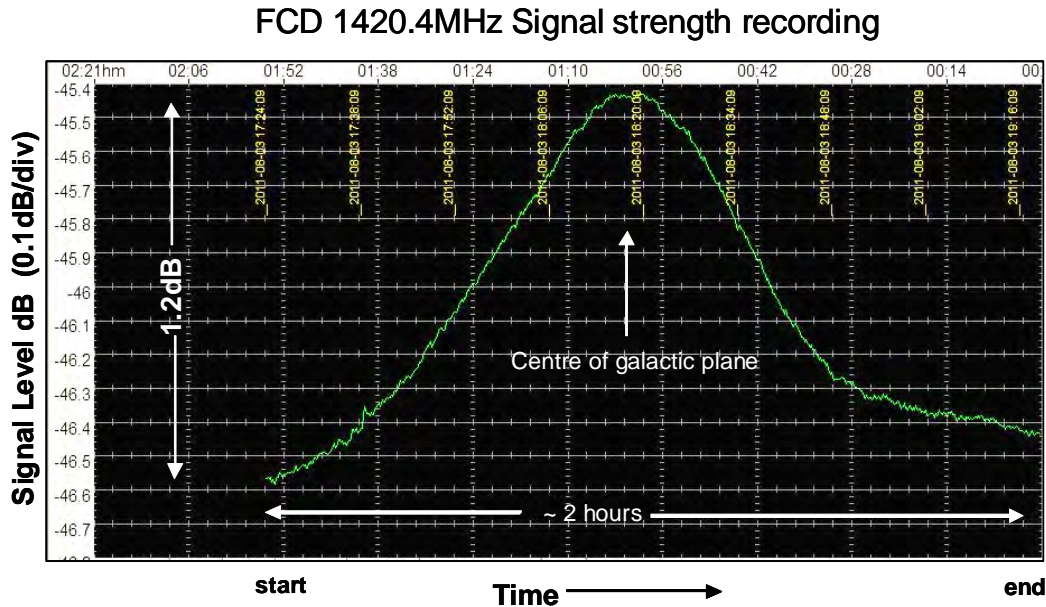

Figure 11 Detection of emission from galactic plane with SDR radio telescope

The signal to noise ratio is $> 1.2\text{dB}$ and this compares well with previous measurements made with conventional receivers, supporting the assertion that a low cost SDR radio telescope using an FCD is a very practical proposition.

The signal trace in Figure 11 can be plotted over the Radio Eyes background to show how the signal peaks as the galactic plane transits across the antenna beam as shown in Figure 12.

This is a satisfactory result and it is clear that good quality radio maps could be made using the SDR telescope by making repeated scans in right ascension at a number of different declinations and then using suitable software to combine the data and produce false-colour maps.

Experiments with a Software Defined Radio Telescope

First Detection of Galactic Plane with a Software Defined Radio Receiver at 1420.4MHz

[FCD Pro SDR+10dB LNA, 200 Av FFT, smoothing=2 WF Feed, 3m Dish F=0.28, end -19:20 UT 3/8/11]

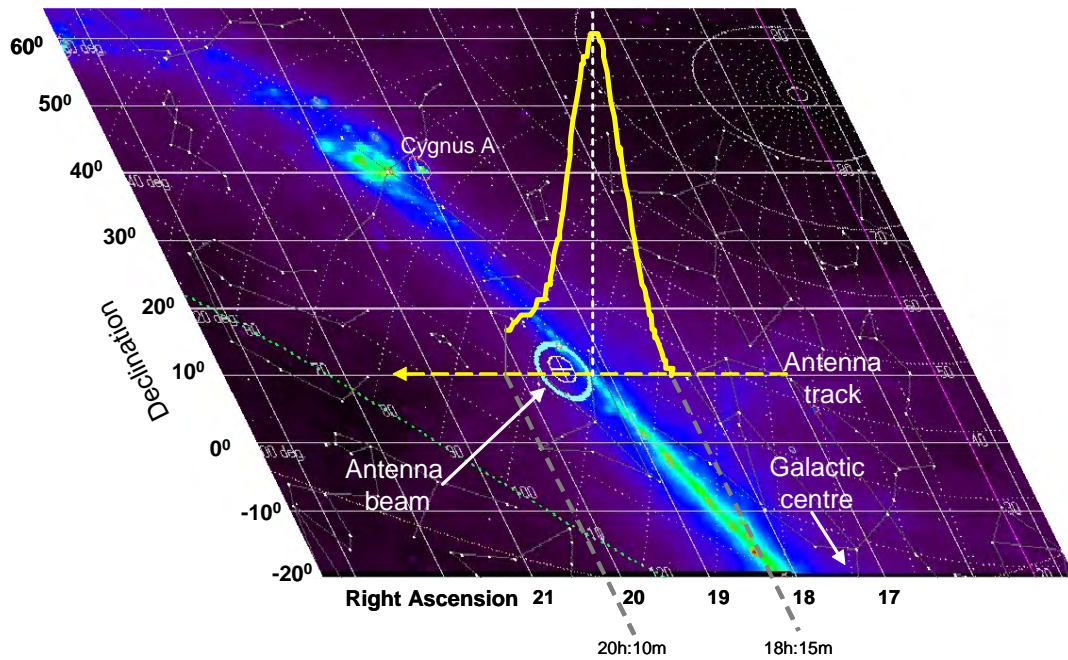

9. Conclusions

A newly available SDR component has been shown to be very capable of acting as the heart of a simple and inexpensive three component radio telescope.

The FUNcube Dongle , or FCD, is now readily available for less than £200 and is both sensitive and stable enough to replace conventional communications receivers as part of a radio telescope.

The FCD SDR is reconfigurable to operate over a wide range of frequencies from VHF to high L band and can be used to observe at many of the frequencies reserved for radio astronomy.

In the future, the possibility may exist to develop an SDR radio telescope 'kit' that amateurs could obtain for a total cost of less than £500* - half the cost of a decent optical telescope. This should encourage many more people interested in radio astronomy to consider setting up a radio telescope of their own.

*Excluding the cost of an antenna dish or suitable Yagi array.

Experiments with a Software Defined Radio Telescope

References

1. http://www.wirelessinnovation.org/page/Introduction_to_SDR
2. Software Defined Radio: Architectures, Systems and Functions (Markus Dillinger, Kambiz Madani, Nancy Alonistioti) Page xxxiii (Wiley & Sons, 2003, ISBN 0-470-85164-3)
3. www.commsfoundation.org/
4. funcube.org.uk/
5. www.funcubedongle.com/
6. groups.yahoo.com/group/FUNcube/
7. www.moetronix.com/spectravue.htm
8. Details available on BAA RAG website (papers by D Morgan)
9. www.dmradas.co.uk
10. www.radiosky.com/

Note on FCD frequency offset

When the FCD has reached its stable operating temperature the device tested had a fixed frequency offset of + 136kHz at 1420MHz.

Thus a very stable signal from an HP 8660C synthesiser at 1420.000000MHz was received on an FCD indicated frequency of 1420.136MHz.

The FCD has a facility to correct for frequency offsets using the 'Frequency correction' window on the main display. If this is reset from 999885 (which is its default) to 999980 the indicated frequency is corrected to 1420.000MHz.

For other examples of the FCD this correction may be different and needs to be set by experimentation using a stable signal source.

Dr David Morgan

www.dmradas.co.uk